

EMC shield clamps for screw assembly

with or without integrated strain relief



EMC shield clamps are used, where the shield of cables must be connected to the earth potential. They are easy to use and effective in earthing single cable shields.

When using types with integrated strain relief cables can be fixed via the cable jacket using cable ties. Thus strain relief in accordance with EN 62444 is achieved. We also offer EMC shield clamps with double strain relief function acc. to PROFINET installation guidelines.

Due to its special design the clamping ranges of the MSKL are very large while the dimensions are comparatively small. (Example: MSKL 3-12, assembled with a 12 mm cable shield: width 26.25 mm). The EMC shield clamp LFZ-M|MSKL is also available as 45° and 90° angled version. The 45° angled type is suitable for the use in frequency converters from various manufacturers. Thus, the cable can be inserted in a 45° angle into the wiring duct. For the cable routing and strain relieving on edges the 90° angled type can be used.

The shield clamps are easily attached to mounting plates via screw.

The shield clamp LFZ-U|SKL is available for M4 or M5 screws. During assembly it is sufficient to loosen the existing screw slightly to be able to slide the clamp underneath before re-tightening the screw.

Shield clamps LFZ-U-AB are especially suitable for mounting on Allen Bradley Powerflex 525 & Powerflex 527 AC drives. Direct contacting on the drive saves space and interference signals are picked up directly at the interference source.

Specifications

Material	Shield clamp: Spring steel, zinc plated Shield bracket: Mild steel, galvanically zinc plated Screw foot: Mild steel, galvanically zinc plated
Properties	vibration proof
Mounting options	Screw type mounting

Advantages & benefits

- Partially with integrated strain relief
- Large contact area
- Shield contact and strain relief separated
- Easy assembly and removal
- The spring design requires no adjustments and will permanently maintain contact to the cable shield
- Shock and vibration resistant, maintenance free
- Integrated double strain relief function acc. to PROFINET installation guidelines

Product types & sizes

LF|MSKL 3-12

Part No.	37608	Length	24 mm
EAN	4251269316	Width	15 mm
	890	Height	26 mm
Package quantity	10	Mounting height	26 mm
No. of shield clamps	1	Hole size	M4
For max. no. of cables	1	No. of screw holes	1
Min. shield diam.	3 mm	Diam. of screw holes	4,1 mm
Max. shield diam.	12 mm		

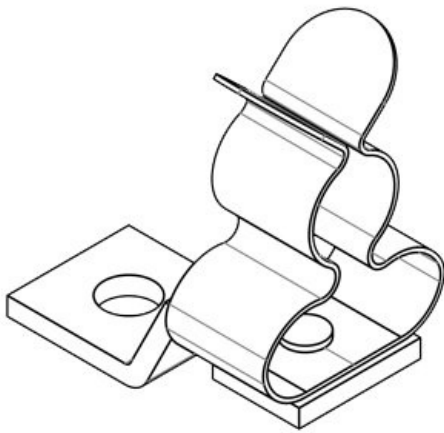

LF|MSKL 8-18

Part No.	37610	Length	24 mm
EAN	4251269316	Width	20 mm
	906	Height	32 mm
Package quantity	10	Mounting height	32 mm
No. of shield clamps	1	Hole size	M4
For max. no. of cables	1	No. of screw holes	1
Min. shield diam.	8 mm	Diam. of screw holes	4,1 mm
Max. shield diam.	18 mm		

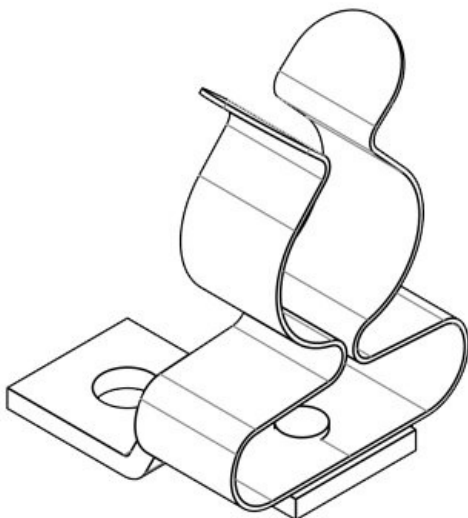

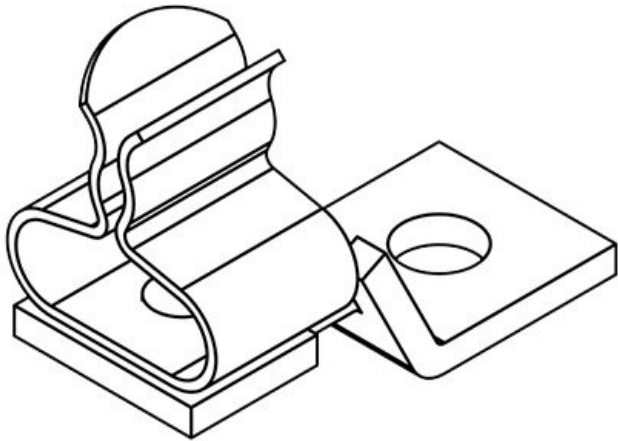

Part No.	36251	Length	24 mm
EAN	4251269302	Width	11,8 mm
	404	Height	18,4 mm
Package quantity	10	Mounting height	18,4 mm
No. of shield clamps	1	Hole size	M4
For max. no. of cables	1	No. of screw holes	1
Min. shield diam.	1,5 mm	Diam. of screw holes	4,1 mm
Max. shield diam.	3 mm		

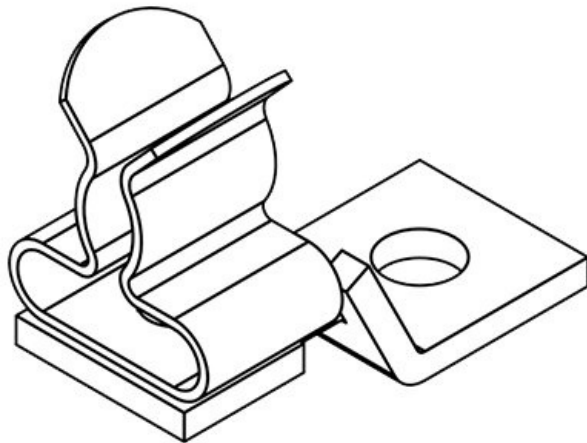

Part No.	36253	Length	24 mm
EAN	4251269302	Width	11,8 mm
	428	Height	19 mm
Package quantity	10	Mounting height	19 mm
No. of shield clamps	1	Hole size	M4
For max. no. of cables	1	No. of screw holes	1
Min. shield diam.	3 mm	Diam. of screw holes	4,1 mm
Max. shield diam.	6 mm		

LF|SKL 6-8

Part No.	36255	Length	24 mm
EAN	4251269302	Width	11,8 mm
	435	Height	20,5 mm
Package quantity	10	Mounting height	20,5 mm
No. of shield clamps	1	Hole size	M4
For max. no. of cables	1	No. of screw holes	1
Min. shield diam.	6 mm	Diam. of screw holes	4,1 mm
Max. shield diam.	8 mm		

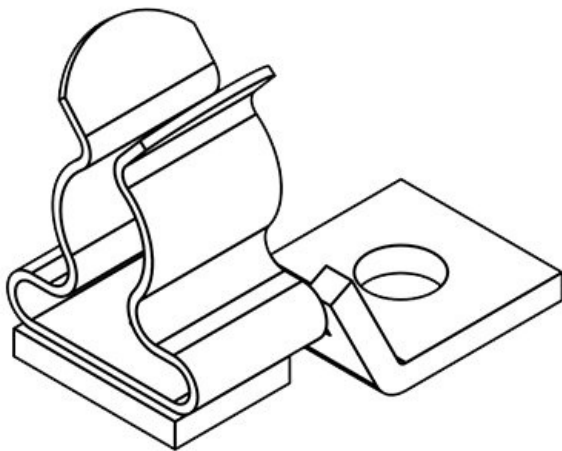

LF|SKL 8-11

Part No.	36256	Length	24 mm
EAN	4251269302	Width	14 mm
	442	Height	25,5 mm
Package quantity	10	Mounting height	25,5 mm
No. of shield clamps	1	Hole size	M4
For max. no. of cables	1	No. of screw holes	1
Min. shield diam.	8 mm	Diam. of screw holes	4,1 mm
Max. shield diam.	11 mm		

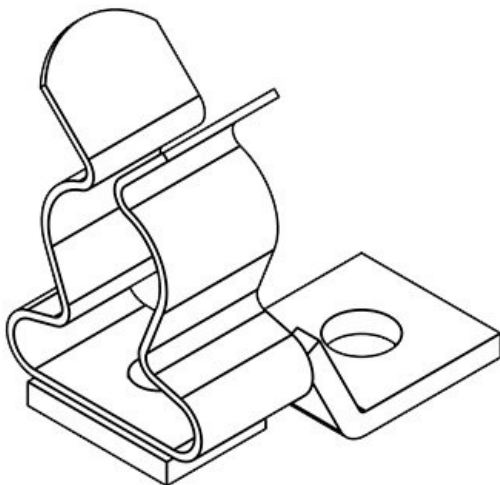

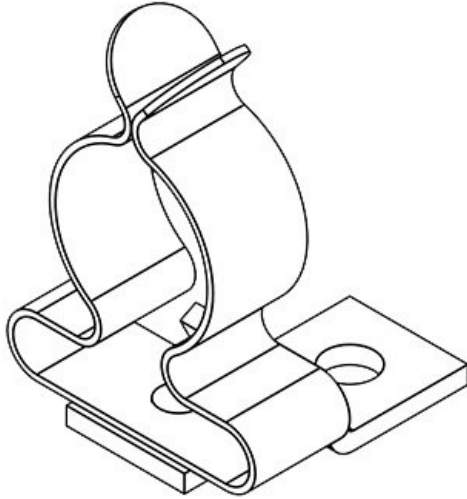

Part No.	36257	Length	24 mm
EAN	4251269302	Width	21 mm
	459	Height	32,5 mm
Package quantity	10	Mounting height	32,5 mm
No. of shield clamps	1	Hole size	M4
For max. no. of cables	1	No. of screw holes	1
Min. shield diam.	11 mm	Diam. of screw holes	4,1 mm
Max. shield diam.	17 mm		



Part No.	36258	Length	24 mm
EAN	4251269302	Width	26,5 mm
	466	Height	40 mm
Package quantity	10	Mounting height	40 mm
No. of shield clamps	1	Hole size	M4
For max. no. of cables	1	No. of screw holes	1
Min. shield diam.	17 mm	Diam. of screw holes	4,1 mm
Max. shield diam.	22 mm		

Part No.	36259	Length	24 mm
EAN	4251269302	Width	35 mm
	473	Height	44,4 mm
Package quantity	10	Mounting height	44,4 mm
No. of shield clamps	1	Hole size	M4
For max. no. of cables	1	No. of screw holes	1
Min. shield diam.	22 mm	Diam. of screw holes	4,1 mm
Max. shield diam.	30 mm		

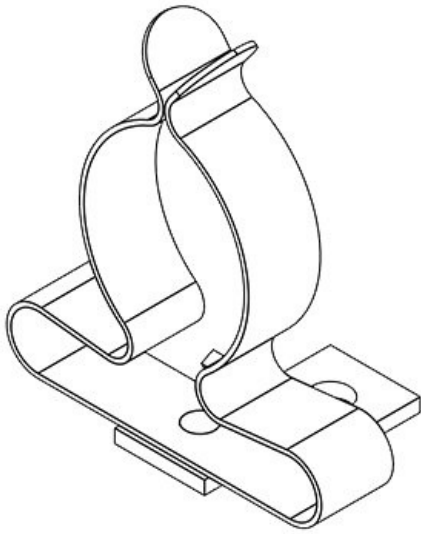

Part No.	37612	Max. shield diam.	12 mm
EAN	4251269316	Length	46,3 mm
	913	Width	15 mm
Package quantity	10	Height	26 mm
No. of shield clamps	1	Mounting height	26 mm
Strain relief (acc. to EN 62444)	1	Hole size	M4
For max. no. of cables	1	No. of screw holes	1
Min. shield diam.	3 mm	Diam. of screw holes	4,1 mm

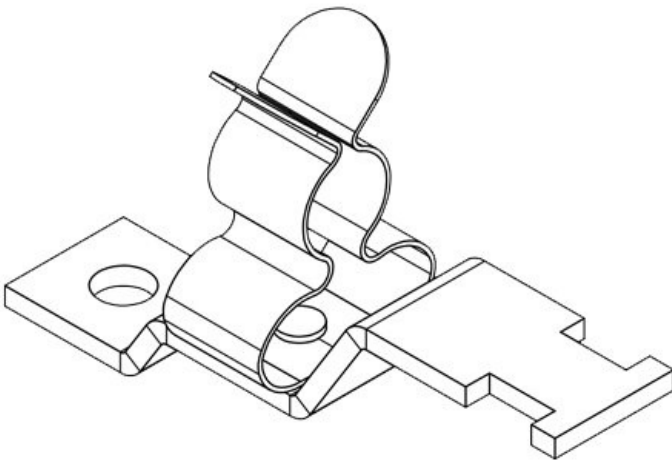

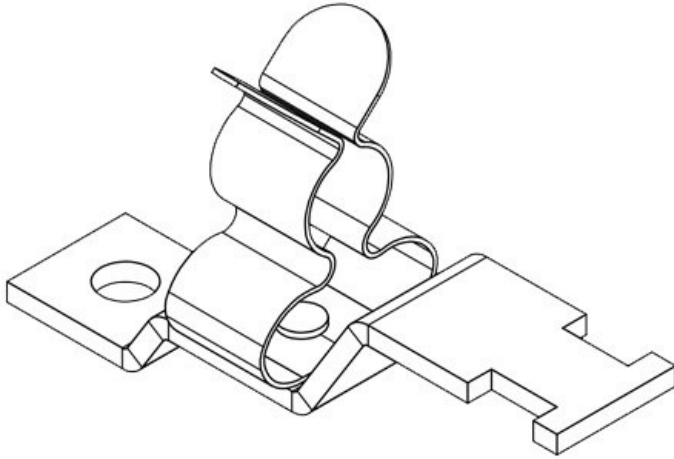

Part No.	37373	Max. shield diam.	12 mm
EAN		Length	46,3 mm
Package quantity	10	Width	15 mm
No. of shield clamps	1	Height	26 mm
Strain relief (acc. to EN 62444)	1	Mounting height	26 mm
For max. no. of cables	1	Hole size	M6
Min. shield diam.	3 mm	No. of screw holes	1
		Diam. of screw holes	6,2 mm

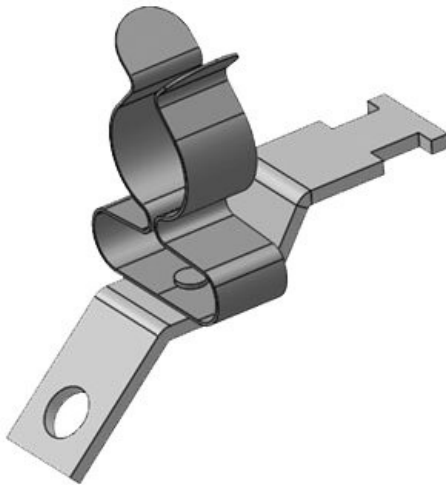

Part No.	37660.1	Max. shield diam.	12 mm
EAN	4251269320	Length	45,1 mm
Package quantity	10	Width	14,9 mm
No. of shield clamps	1	Height	33,1 mm
Strain relief (acc. to EN 62444)	1	Hole size	M4
For max. no. of cables	1	No. of screw holes	1
Min. shield diam.	3 mm	Diam. of screw holes	4,1 mm

Part No.	37661.1	Max. shield	12 mm
EAN	4251269321	diam.	
	450	Length	34,7 mm
Package	10	Width	14,9 mm
quantity		Height	37,1 mm
No. of shield	1	Hole size	M4
clamps		No. of screw	1
Strain relief	1	holes	
(acc. to EN		Diam. of screw	4,1 mm
62444)		holes	
For max. no. of	1		
cables			
Min. shield	3 mm		
diam.			

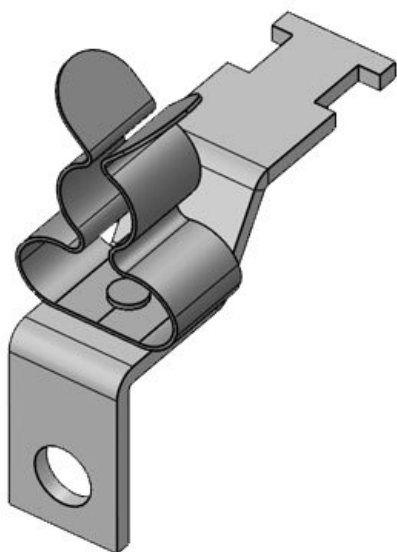

Part No.	37614	Max. shield	18 mm
EAN	4251269316	diam.	
	920	Length	46,3 mm
Package	10	Width	20 mm
quantity		Height	32,2 mm
No. of shield	1	Mounting	32,2 mm
clamps		height	
Strain relief	1	Hole size	M4
(acc. to EN		No. of screw	1
62444)		holes	
For max. no. of	1	Diam. of screw	4,1 mm
cables		holes	
Min. shield	8 mm		
diam.			

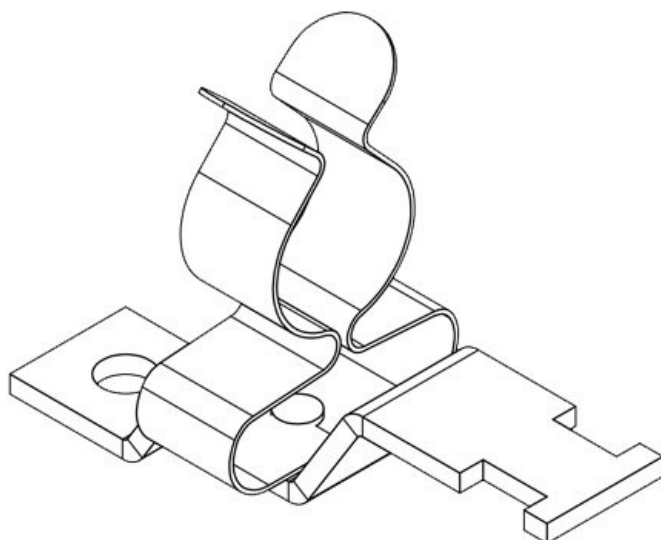

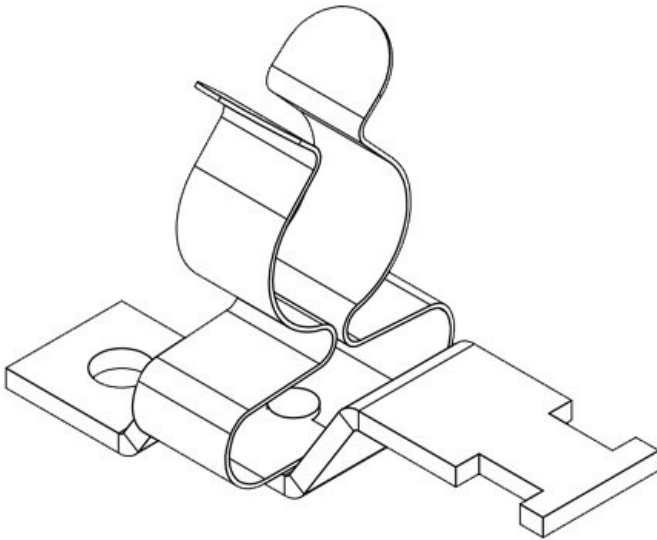

Part No.	37388	Max. shield diam.	18 mm
EAN		Length	46,3 mm
Package quantity	10	Width	20 mm
No. of shield clamps	1	Height	32,2 mm
Strain relief (acc. to EN 62444)	1	Mounting height	32,2 mm
For max. no. of cables	1	Hole size	M6
Min. shield diam.	8 mm	No. of screw holes	1
		Diam. of screw holes	6,2 mm

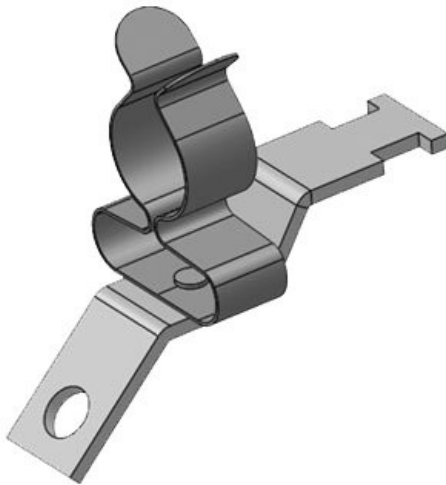

Part No.	37660.2	Max. shield diam.	18 mm
EAN	4251269320	Length	45,1 mm
Package quantity	10	Width	19,7 mm
No. of shield clamps	1	Height	39,3 mm
Strain relief (acc. to EN 62444)	1	Hole size	M4
For max. no. of cables	1	No. of screw holes	1
Min. shield diam.	8 mm	Diam. of screw holes	4,1 mm

Part No.	37661.2	Max. shield	18 mm
EAN	4251269321	diam.	
	467	Length	34,7 mm
Package	10	Width	19,4 mm
quantity		Height	43,3 mm
No. of shield	1	Hole size	M4
clamps		No. of screw	1
Strain relief	1	holes	
(acc. to EN		Diam. of screw	4,1 mm
62444)		holes	
For max. no. of	1		
cables			
Min. shield	8 mm		
diam.			

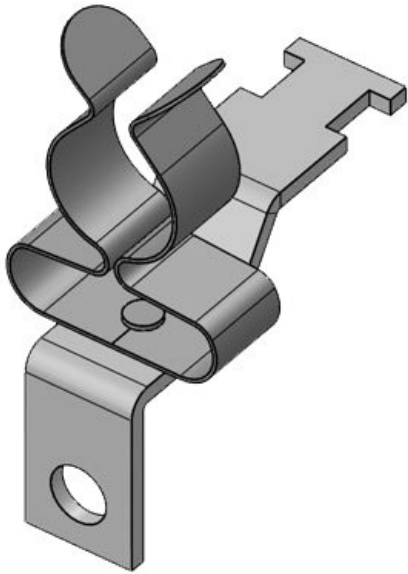

Part No.	36910	Max. shield	3 mm
EAN	4251269305	diam.	
	054	Length	44,4 mm
Package	10	Width	11,8 mm
quantity		Height	18,4 mm
No. of shield	1	Mounting	18,4 mm
clamps		height	
Strain relief	1	Hole size	M4
(acc. to EN		No. of screw	1
62444)		holes	
For max. no. of	1	Diam. of screw	4,1 mm
cables		holes	
Min. shield	1,5 mm		
diam.			

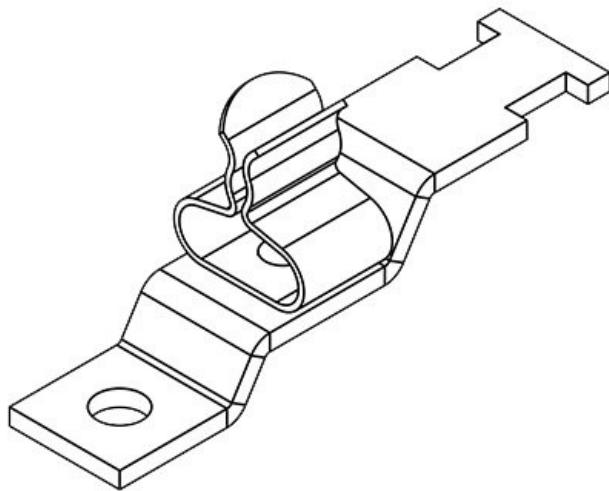

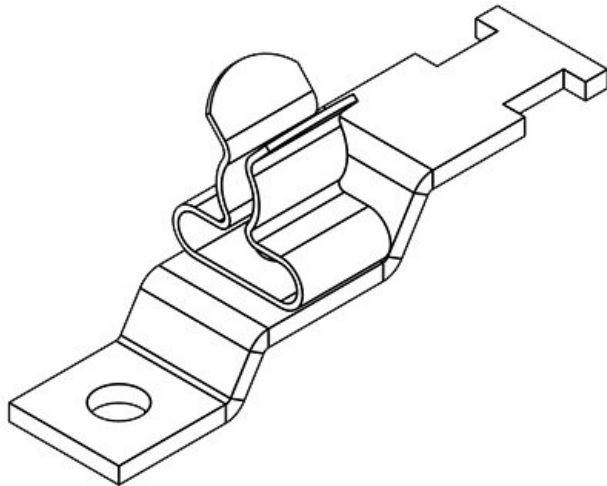

Part No.	36915	Max. shield	6 mm
EAN	4251269305	diam.	
	061	Length	44,4 mm
Package	10	Width	11,8 mm
quantity		Height	19,1 mm
No. of shield	1	Mounting	19,1 mm
clamps		height	
Strain relief	1	Hole size	M4
(acc. to EN		No. of screw	1
62444)		holes	
For max. no. of		Diam. of screw	4,1 mm
cables		holes	
Min. shield	3 mm		
diam.			

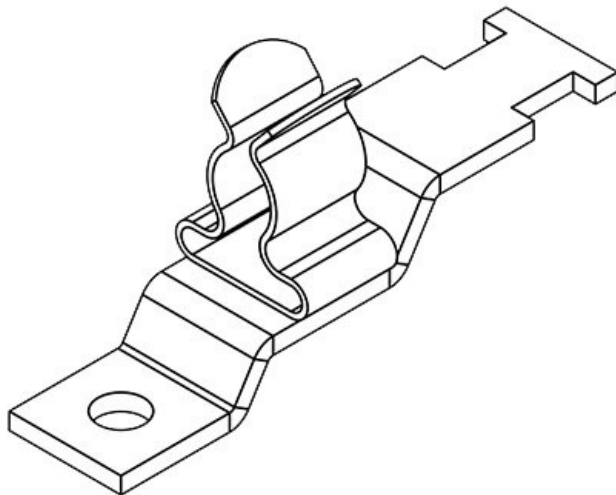

Part No.	36920	Max. shield	8 mm
EAN	4251269305	diam.	
	078	Length	44,4 mm
Package	10	Width	11,8 mm
quantity		Height	20,5 mm
No. of shield	1	Mounting	20,5 mm
clamps		height	
Strain relief	1	Hole size	M4
(acc. to EN		No. of screw	1
62444)		holes	
For max. no. of		Diam. of screw	4,1 mm
cables		holes	
Min. shield	6 mm		
diam.			

Part No.	36925	Max. shield	11 mm
EAN	4251269305	diam.	
	085	Length	44,4 mm
Package	10	Width	14 mm
quantity		Height	25,5 mm
No. of shield	1	Mounting	25,5 mm
clamps		height	
Strain relief	1	Hole size	M4
(acc. to EN		No. of screw	1
62444)		holes	
For max. no. of	1	Diam. of screw	4,1 mm
cables		holes	
Min. shield	8 mm		
diam.			

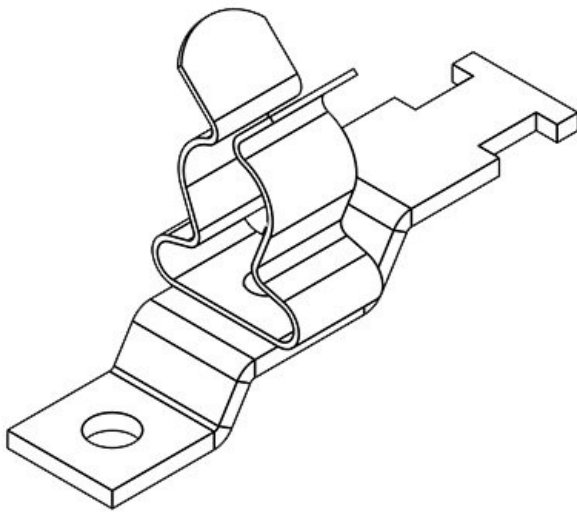

Part No.	36930	Max. shield	17 mm
EAN	4251269305	diam.	
	092	Length	55 mm
Package	10	Width	21 mm
quantity		Height	33 mm
No. of shield	1	Mounting	33 mm
clamps		height	
Strain relief	1	Hole size	M4
(acc. to EN		No. of screw	1
62444)		holes	
For max. no. of	1	Diam. of screw	4,1 mm
cables		holes	
Min. shield	11 mm		
diam.			

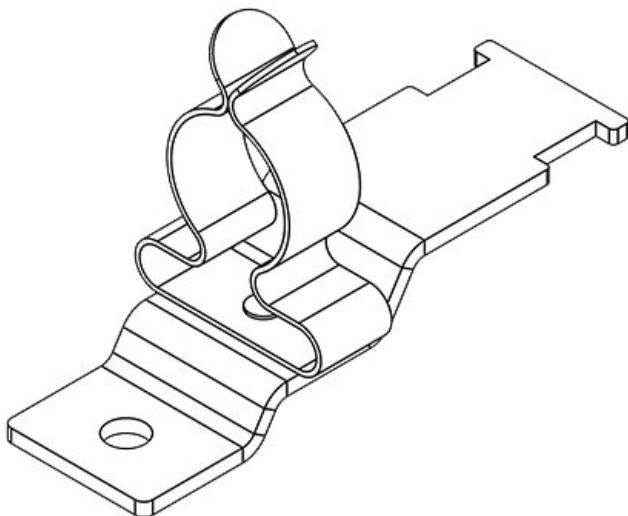

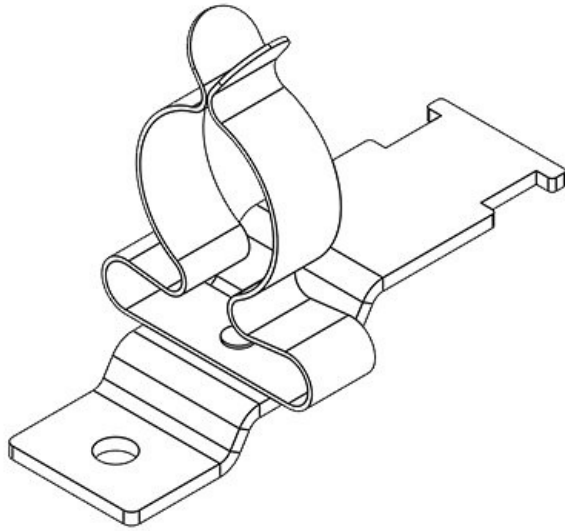

Part No.	36935	Max. shield diam.	22 mm
EAN	4251269305	Length	55 mm
Package quantity	10	Width	26,5 mm
No. of shield clamps	1	Height	40 mm
Strain relief (acc. to EN 62444)	1	Mounting height	40 mm
For max. no. of cables	1	Hole size	M4
Min. shield diam.	17 mm	No. of screw holes	1
		Diam. of screw holes	4,1 mm

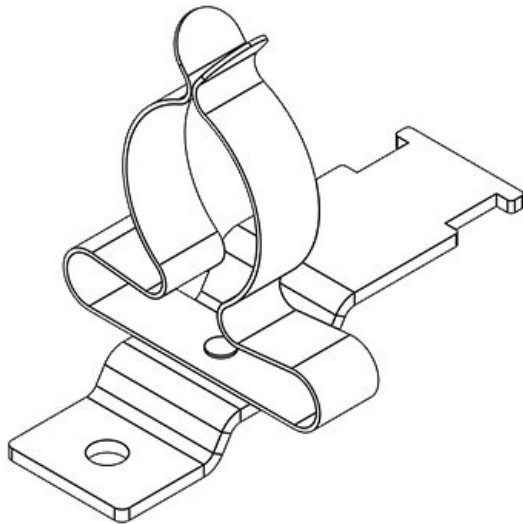

Part No.	36940	Max. shield diam.	30 mm
EAN	4251269305	Length	55 mm
Package quantity	10	Width	35 mm
No. of shield clamps	1	Height	44 mm
Strain relief (acc. to EN 62444)	1	Mounting height	44 mm
For max. no. of cables	1	Hole size	M4
Min. shield diam.	22 mm	No. of screw holes	1
		Diam. of screw holes	4,1 mm

Part No.	36941	Max. shield diam.	38 mm
EAN	4251269319	Length	55 mm
	082	Width	46,5 mm
Package quantity	10	Height	67 mm
No. of shield clamps	1	Mounting height	67 mm
Strain relief (acc. to EN 62444)	1	Hole size	M4
For max. no. of cables	1	No. of screw holes	1
Min. shield diam.	30 mm	Diam. of screw holes	4,2 mm

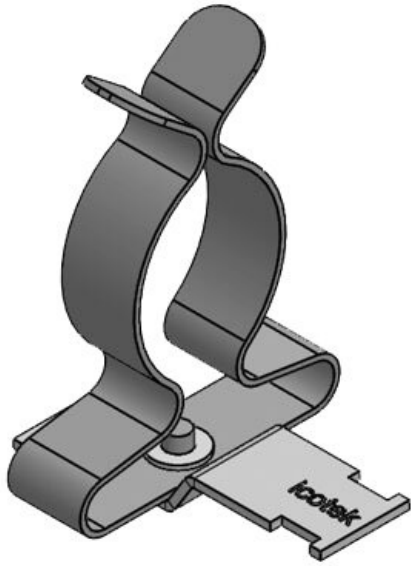

Part No.	36886.1	Min. shield diam.	1,5 mm
EAN	4251269304	Max. shield diam.	3 mm
	972	Width	11,8 mm
Package quantity	10	Height	18,4 mm
No. of shield clamps	1	Mounting height	18,4 mm
Length	44,4 mm	Hole size	M4
Strain relief (acc. to EN 62444)	1	No. of screw holes	1
For max. no. of cables	1	Diam. of screw holes	4,2 mm

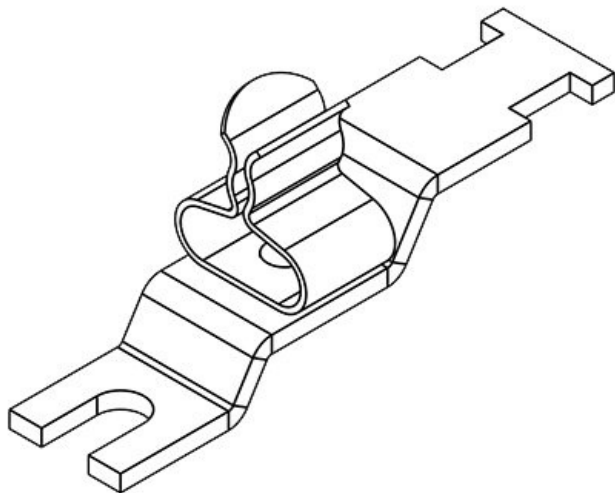

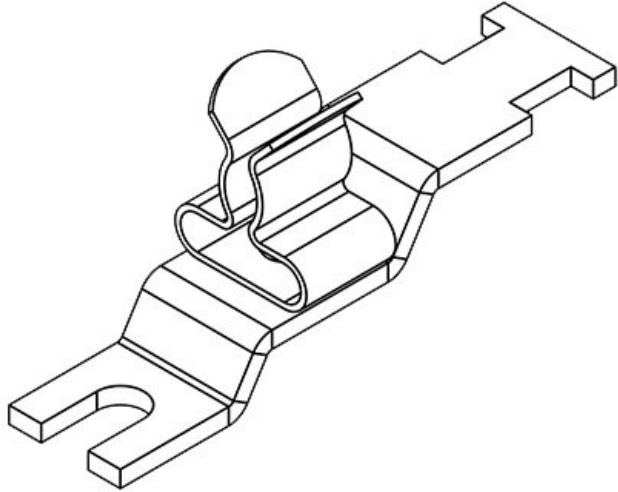

Part No.	36886.2	Min. shield diam.	3 mm
EAN	4251269304	Max. shield diam.	6 mm
Package quantity	10	Width	11,8 mm
No. of shield clamps	1	Height	19,1 mm
Length	44,4 mm	Mounting height	19,1 mm
Strain relief (acc. to EN 62444)	1	Hole size	M4
For max. no. of cables	1	No. of screw holes	1
		Diam. of screw holes	4,2 mm

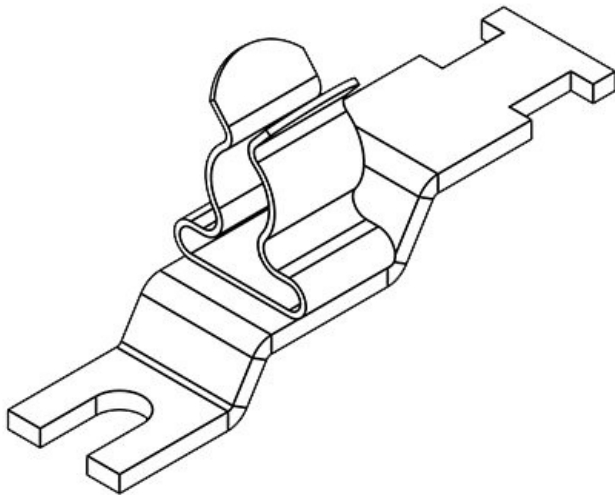

Part No.	36886.3	Min. shield diam.	6 mm
EAN	4251269304	Max. shield diam.	8 mm
Package quantity	10	Width	11,8 mm
No. of shield clamps	1	Height	20,5 mm
Length	44,4 mm	Mounting height	20,5 mm
Strain relief (acc. to EN 62444)	1	Hole size	M4
For max. no. of cables	1	No. of screw holes	1
		Diam. of screw holes	4,2 mm

Part No.	36886.4	Min. shield diam.	8 mm
EAN	4251269305009	Max. shield diam.	11 mm
Package quantity	10	Width	14 mm
No. of shield clamps	1	Height	25,5 mm
Length	44,4 mm	Mounting height	25,5 mm
Strain relief (acc. to EN 62444)	1	Hole size	M4
For max. no. of cables	1	No. of screw holes	1
		Diam. of screw holes	4,2 mm

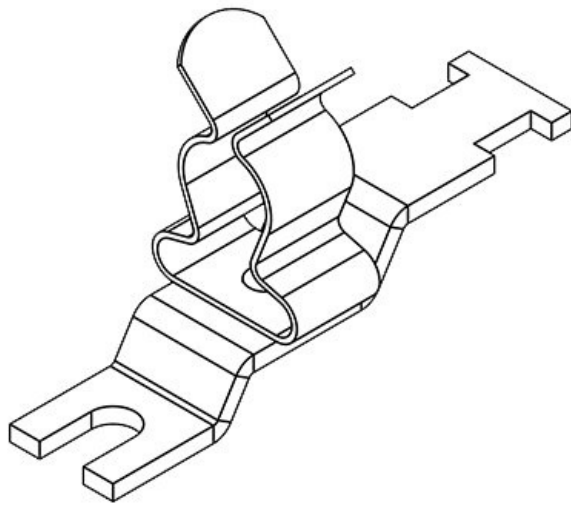

Part No.	36887.1	Min. shield diam.	1,5 mm
EAN	4251269305016	Max. shield diam.	3 mm
Package quantity	10	Width	11,8 mm
No. of shield clamps	1	Height	18,4 mm
Length	44,4 mm	Mounting height	18,4 mm
Strain relief (acc. to EN 62444)	1	Hole size	M5
For max. no. of cables	1	No. of screw holes	1
		Diam. of screw holes	5,2 mm

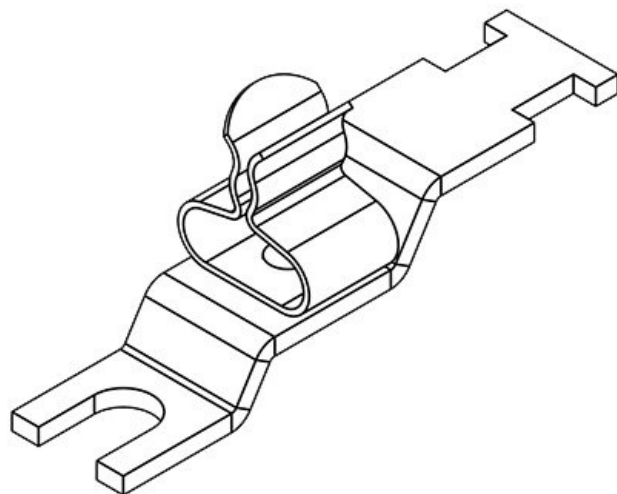

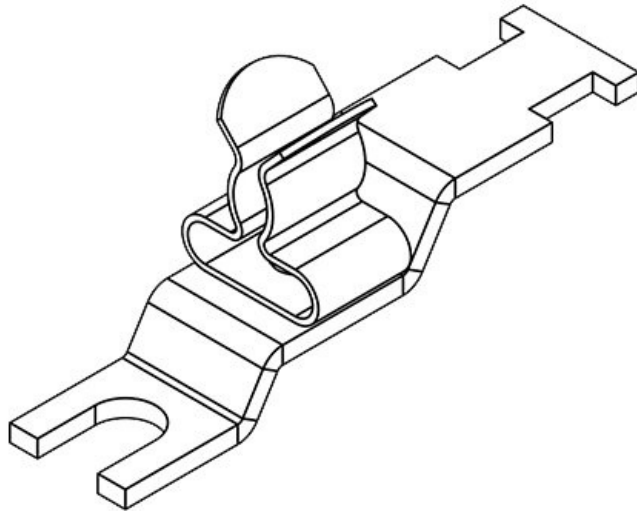

Part No.	36887.2	Min. shield diam.	3 mm
EAN	4251269305023	Max. shield diam.	6 mm
Package quantity	10	Width	11,8 mm
No. of shield clamps	1	Height	19,1 mm
Length	44,4 mm	Mounting height	19,1 mm
Strain relief (acc. to EN 62444)	1	Hole size	M5
For max. no. of cables	1	No. of screw holes	1
		Diam. of screw holes	5,2 mm

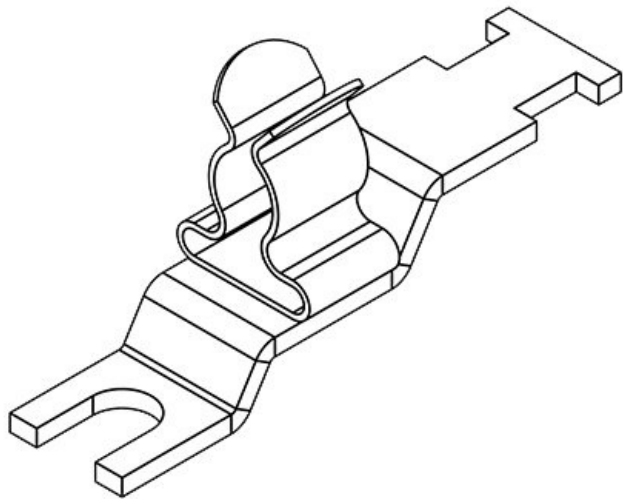

Part No.	36887.3	Min. shield diam.	6 mm
EAN	4251269305030	Max. shield diam.	8 mm
Package quantity	10	Width	11,8 mm
No. of shield clamps	1	Height	20,5 mm
Length	44,4 mm	Mounting height	20,5 mm
Strain relief (acc. to EN 62444)	1	Hole size	M5
For max. no. of cables	1	No. of screw holes	1
		Diam. of screw holes	5,2 mm

Part No.	36887.4	Min. shield	8 mm
EAN	4251269305	diam.	
	047	Max. shield	11 mm
Package	10	diam.	
quantity		Width	14 mm
No. of shield	1	Height	25,5 mm
clamps		Mounting	25,5 mm
Length	44,4 mm	height	
Strain relief	1	Hole size	M5
(acc. to EN		No. of screw	1
62444)		holes	
For max. no. of	1	Diam. of screw	5,2 mm
cables		holes	

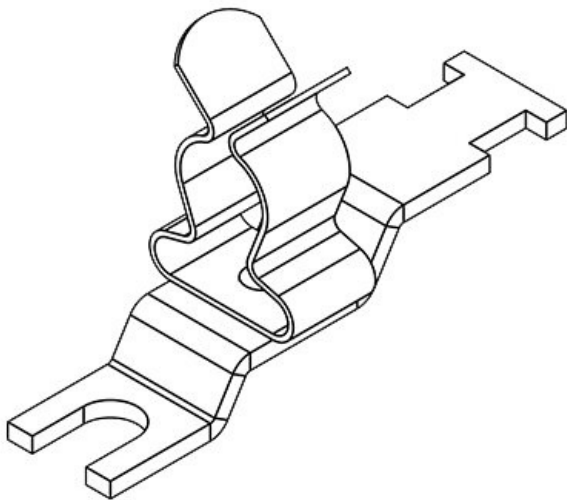

Part No.	36948.3	Min. shield	6 mm
EAN	4251269322	diam.	
	365	Max. shield	8 mm
Package	10	diam.	
quantity		Width	11,8 mm
No. of shield	1	Height	27,2 mm
clamps		Mounting	27,2 mm
Length	43,6 mm	height	
Strain relief	1	Hole size	M4
(acc. to EN		No. of screw	1
62444)		holes	
For max. no. of	1	Diam. of screw	4,3 mm
cables		holes	

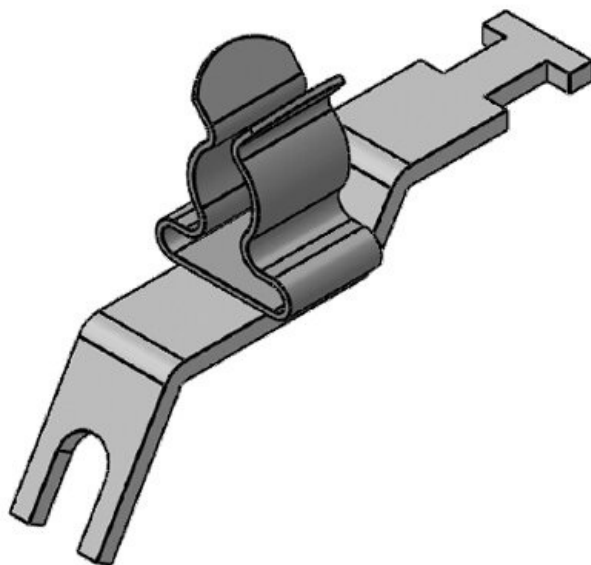

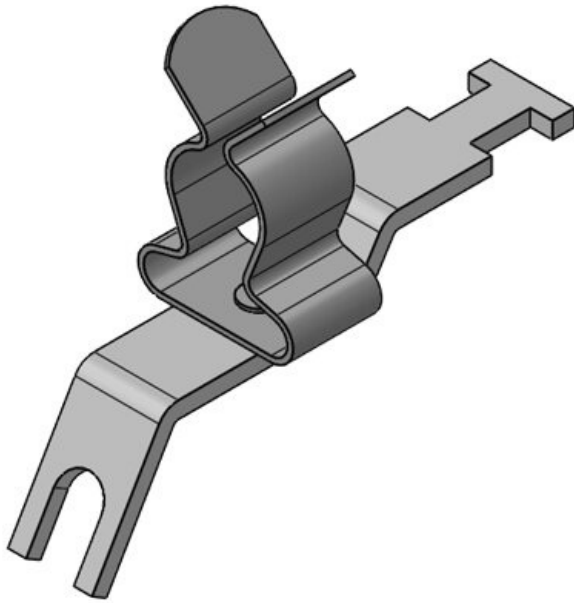

Part No.	36948.4	Min. shield diam.	8 mm
EAN	4251269322	Max. shield diam.	11 mm
Package quantity	10	Width	14 mm
No. of shield clamps	1	Height	32,2 mm
Length	43,6 mm	Mounting height	32,2 mm
Strain relief (acc. to EN 62444)	1	Hole size	M4
For max. no. of cables	1	No. of screw holes	1
		Diam. of screw holes	4,3 mm

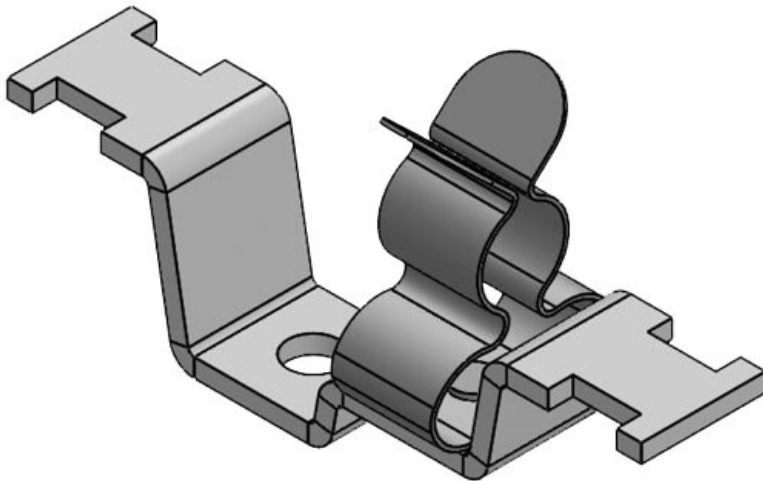

Part No.	37665.150	Min. shield diam.	3 mm
EAN	4251269320	Max. shield diam.	12 mm
Package quantity	10	Width	14,9 mm
No. of shield clamps	1	Height	26 mm
Length	51 mm	Mounting height	26 mm
Strain relief (acc. to EN 62444)	1	Hole size	M4
For max. no. of cables	1	No. of screw holes	1
		Diam. of screw holes	4,1 mm

Part No.	37666.150	Min. shield diam.	8 mm
EAN	4251269320	Max. shield diam.	18 mm
Package quantity	10	Width	19,7 mm
No. of shield clamps	1	Height	32,2 mm
Length	51 mm	Mounting height	32,2 mm
Strain relief (acc. to EN 62444)	1	Hole size	M4
For max. no. of cables	1	No. of screw holes	1
		Diam. of screw holes	4,1 mm

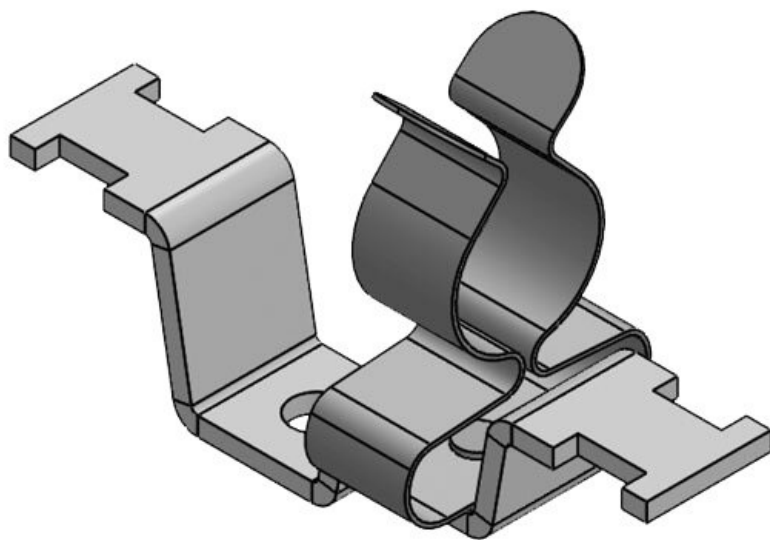

Part No.	37590.150	Min. shield diam.	17 mm
EAN	4251269324	Max. shield diam.	22 mm
Package quantity	10	Width	21 mm
No. of shield clamps	1	Height	32,5 mm
Length	51 mm	Mounting height	32,5 mm
Strain relief (acc. to EN 62444)	1	Hole size	M4
For max. no. of cables	1	No. of screw holes	1
		Diam. of screw holes	4,1 mm

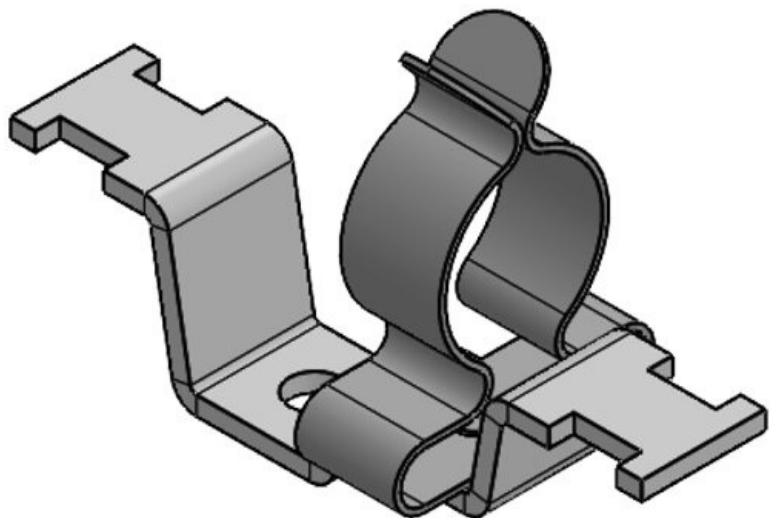

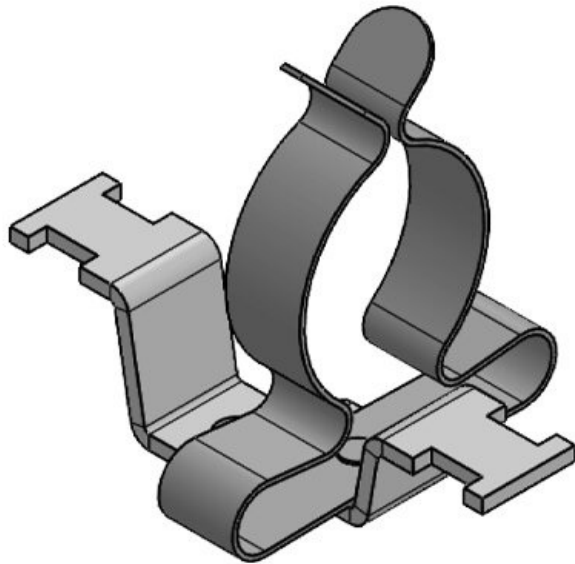

Part No.	37591.150	Min. shield diam.	22 mm
EAN	4251269324	Max. shield diam.	30 mm
Package quantity	10	Width	35 mm
No. of shield clamps	1	Height	41,3 mm
Length	51 mm	Mounting height	41,3 mm
Strain relief (acc. to EN 62444)	1	Hole size	M4
For max. no. of cables		No. of screw holes	1
		Diam. of screw holes	4,1 mm